

National Security Engineering Research

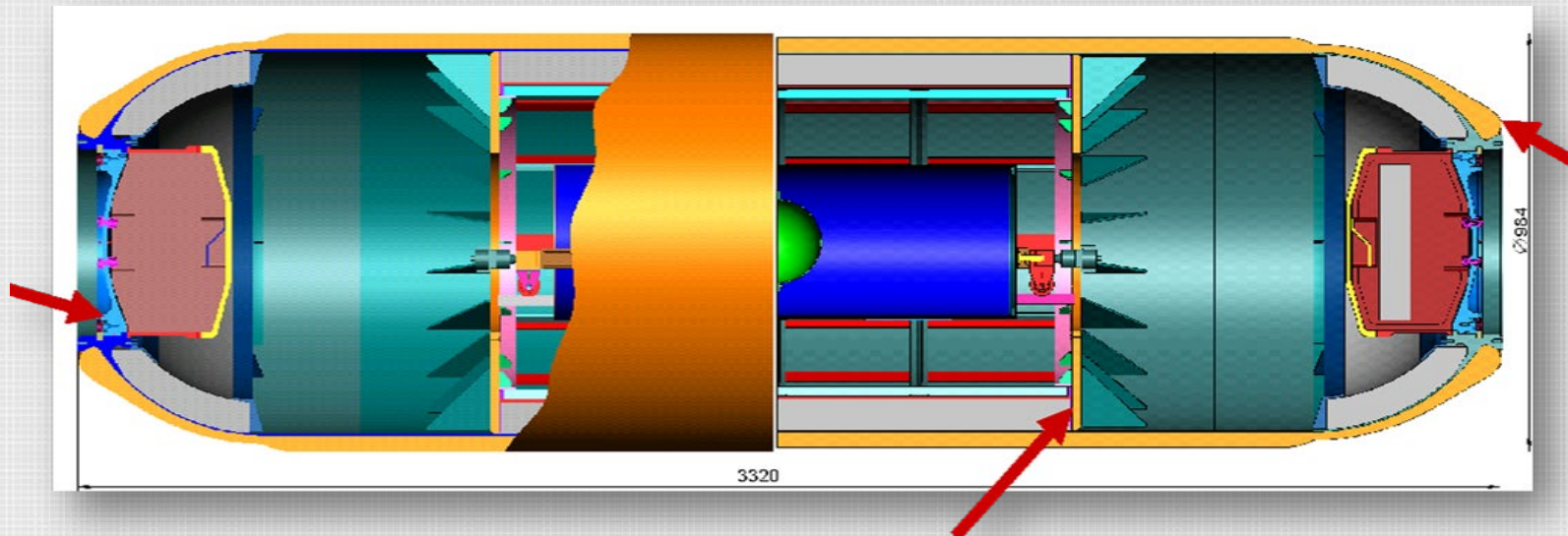

National Security Engineering Research



Dr. Rama Venkat
Dean, College of Engineering
Phone: (702) 895-1094
Email: Rama.Venkat@unlv.edu



Dr. Mohamed Trabia
Associate Dean, College of Engineering
Phone: (702) 895-0957
Email: Mohamed.Trabia@unlv.edu

Engineering security systems are an important area of research to the State of Nevada and the nation. UNLV researchers address many challenges related to security engineering, including blast containment, shock mitigation, and smart grid security. Our researchers have been funded by various federal and state agencies as well as industrial partners.

We would like to introduce you to some of our faculty. Please contact us if we can help with future collaboration.

Graphic on Slide 1: Structural analysis and dynamics (Dr. Brendan O'Toole).

National Security Engineering

Research Areas of Expertise

- Computational radiation transport
- Interconnection networks, photonic interconnects
- Computer/ microprocessor architecture
- Radiation detection methods
- Active neutron interrogation and non-destructive assay of materials
- Nuclear safeguards and nonproliferation
- Pulsed-ray radiography to detect nuclear materials
- Security and privacy in AI
- GaN semiconductors and devices
- Radiation-hard electronics, optoelectronics, and imaging systems
- Digital search warrants
- Homeland security
- Secure protocol development for software and network applications
- Wireless mesh network routing and security
- Structural analysis, failure analysis, experimental mechanics
- Structural dynamics, explosives, and impact analysis
- Computational simulation of highly dynamic events
- Material characterization, custom component testing
- Progressive collapse resistance of structures
- Simulation of structures subjected to normal and extreme loading events
- Earthquake engineering
- Man-In-The-Middle (MITM) attack with tempered SSL certificate detection
- Cybersecurity data analytics

National Security Engineering Research

Why UNLV?

- Las Vegas is a dynamic and growing city with a population that includes multiple ethnicities and age groups.
- UNLV has a strong team of researchers who collaborate on various areas of security engineering studies.
- UNLV researchers also have developed strong collaboration ties with key industrial partners including:
 - **Mission Support and Test Services, LLC (MSTS)**
MSTS manages operations at the Nevada National Security Site (NNSS) – formerly known as the Nevada Test Site – and its related facilities and laboratories for the Department of Energy's National Nuclear Security Administration.
 - **Varian Medical Systems**
Varian's Security and Inspection Products group, based in Las Vegas, provides cargo screening systems with linear accelerators for X-ray imaging for cargo screening operations.



Faculty Involved in National Security Engineering Research

- **Dr. Alexander Barzilov**
Professor, Department of Mechanical Engineering
- **Dr. Yingtao Jiang**
Professor, Associate Dean for Undergraduate Programs
- **Dr. Ju-Yeon Jo**
Professor, Department of Computer Science
- **Dr. Yoohwan Kim, CISSP**
Professor, Department of Computer Science
- **Dr. Shahram Latifi, P.E.**
*Professor, Department of Electrical and Computer Engineering
Director, Center for Information Technology and Algorithms (CITA)*
- **Dr. Brendan J. O'Toole**
*Professor, Department of Mechanical Engineering
Director, Center of Materials and Structures*
- **Dr. Emma Regentova**
Professor, Department of Electrical and Computer Engineering
- **Dr. Ke-Xun (Kevin) Sun, P.E.**
Professor, Department of Electrical and Computer Engineering
- **Dr. Ying Tian, P.E.**
Professor, Department of Civil and Environmental Engineering and Construction
- **Dr. Mohamed Trabia**
*Professor, ASME Fellow, Department of Mechanical Engineering
Associate Dean for Research, Graduate Studies, and Computing*
- **Dr. Zuobin Xiong**
Assistant Professor, Department of Computer Science
- **Dr. Mei Yang**
Professor, Department of Electrical and Computer Engineering

National Security Engineering Research

Additional Resources

[Center for Materials and Structures](#)

[Center for the Advanced Study of Algorithms \(CASA\)](#)

[Center for Information Technology and Algorithms \(CITA\)](#)

National Security Engineering

Research Highlights

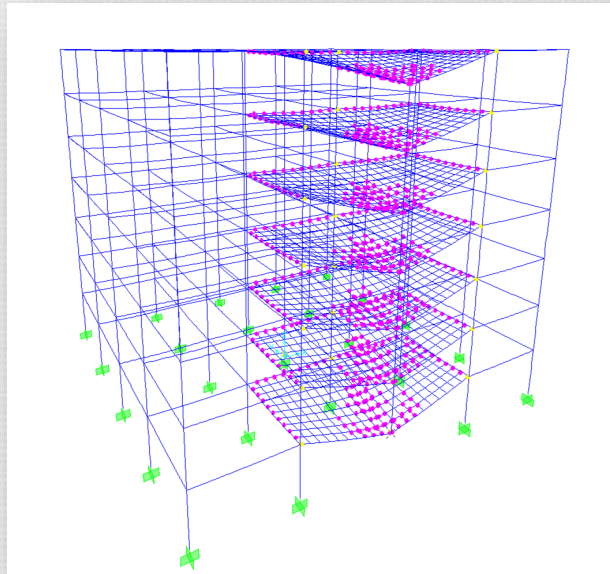

National Security Engineering Research

Dr. Alexander Barzilov

Professor, Department of Mechanical Engineering

Phone: (702) 895-4325

Email: alexander.barzilov@unlv.edu

- Expertise
 - Radiation detection methods
 - Ambient temperature semiconductor radiation detectors
 - Multi-mode scintillation radiation detectors
 - Active neutron interrogation and non-destructive assay of materials
 - Prompt gamma neutron activation analysis
 - Computational radiation transport
 - Security applications of particle accelerators
 - Nuclear safeguards and nonproliferation
 - Nuclear robotics and remote sensing of radiation
 - Nuclear physics

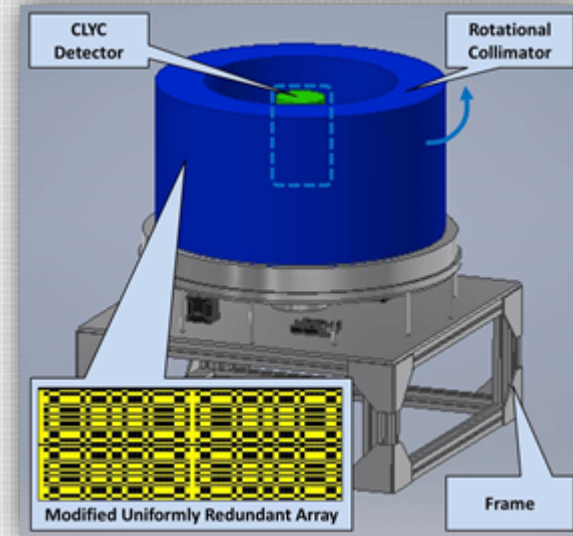
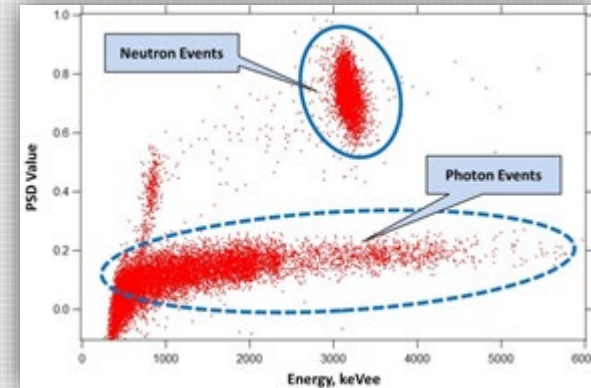

Dr. Alexander Barzilov

Professor, Department of Mechanical Engineering



Relevant Publications

- N. Fomin, R. Alarcon, L. Alonzi, E. Askanazi, S. Baeßler, S. Balascuta, L. Barrón-Palos, A. Barzilov, D. Blyth, J.D. Bowman, et al., "Measurement of the Parity-Odd Angular Distribution of Gamma Rays from Polarized Neutron Capture on ^{35}Cl ," *Physical Review C* 106(1), 015504 (2022).
- W.H. Trzaska, A. Barzilov, T. Enqvist, K. Jedrzejczak, J. Joutsenvaara, M. Kasztelan, O. Kotavaara, P. Kuusiniemi, K.K. Loo, J. Orzechowski, J. Puputti, M. Slupecki, J. Szabelski, I. Usoskin, T.E. Ward, "NEMESIS Setup for Indirect Detection of WIMPs," *Nuclear Instruments and Methods in Physics Research A* 1040, 167223 (2022).
- A. Guckes, A. Barzilov, P. Guss, "Experimental Study of Directional Detection of Neutrons and Gamma Rays Using an Elpasolite Scintillator Array," *Nuclear Instruments and Methods in Physics Research Section A* 992, 165028 (2021).
- A. Barzilov, M. Kazemeini, "Unmanned Aerial System Integrated Sensor for Remote Gamma and Neutron Monitoring," *Sensors* 20, 5529 (2020).
- A. Barzilov, A. Guckes, P. Guss, "Directional Detection of Neutrons and Photons using Elpasolites: Computational Study," *Radiation Measurements* 124, 127-131 (2019).
- W. Yim, Z. Cook, M. Kazemeini, A. Barzilov, "Low-Altitude Contour Mapping of Radiation Fields Using UAS Swarm," *Intelligent Service Robotics* 12, 219-230 (2019).
- M. Kazemeini, A. Barzilov, W. Yim, J. Lee, "Gamma Ray and Neutron Sensors for Remote Monitoring Using Aerial Robotic Platforms," *Sensors & Transducers* 229(1), 47-54 (2019).
- A. Barzilov, A. Guckes, "Time Encoded Imaging of Neutrons and Photons Using CLYC Detector Equipped with a Dual Mode Collimator," *Sensors & Transducers* 229(1), 78-83 (2019).
- D. Blyth, J. Fry, N. Fomin, R. Alarcon, L. Alonzi, E. Askanazi, S. Baeßler, S. Balascuta, L. Barrón-Palos, A. Barzilov, J.D. Bowman, et al., "First Observation of P-odd Gamma Asymmetry in Polarized Neutron Capture on Hydrogen," *Physical Review Letters* 121, 242002 (2018).
- M. Kazemeini, Z. Cook, J. Lee, A. Barzilov, W. Yim, "Plug-and-Play Radiation Sensor Components for Unmanned Aerial System Platform," *Journal of Radioanalytical & Nuclear Chemistry* 318, 1797 (2018).

National Security Engineering Research

Dr. Yingtao Jiang

Professor, Associate Dean for Undergraduate Programs

Phone: (702) 895-2533

Email: yingtao.jiang@unlv.edu

- Expertise
 - Sensors and instrumentation
 - Signal processing, instrumentation, and medical informatics
 - Semiconductor/microelectronics/integrated circuits
 - Wireless communications and security
 - Computer/microprocessor architectures
 - Renewable energy

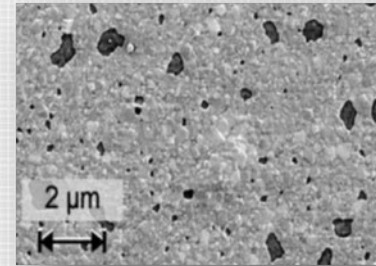

Yttria Stabilized Zirconia (YSZs) O₂ sensor for monitoring nuclear reactor coolant



22-layer PCB board (NoC emulator)

An MRR with E/O tuning circuit

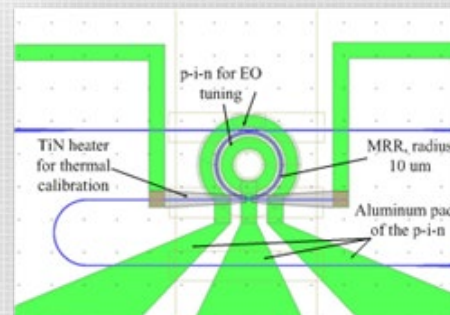

Dr. Yingtao Jiang

Professor, Associate Dean for Undergraduate Programs

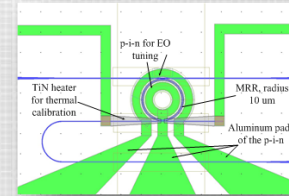

Relevant Publications

- H. Huang, X. Wang, Yingtao Jiang, A. K. Singh, M. Yang, and L. Huang, "Detection of and Countermeasures against Thermal Convert Channel in Many-core Systems," *IEEE Transactions on Computer-Aided Design of Integrated Circuits and Systems*, vol. 41, no. 2, pp. 252-265, Feb. 2022.
- Z. Zhang, P. Liu, W. Wang, S. Li, P. Wang, and Yingtao Jiang, "High Performance Password Recovery Hardware going from GPU to Hybrid CPU-FPGA Platform," *IEEE Consumer Electronics Magazine*, vol. 11, no. 1, pp. 80-87, Jan. 2022.
- Y. Zhao, X. Wang, Yingtao Jiang, L. Wang, A. K. Singh, L. Huang and M. Yang, "An Enhanced Planned Obsolescence Attack by Aging Networks-on-Chip," *Journal of System Architecture*, vol. 117, Aug. 2021.
- J. Wang, X. Wang, Yingtao Jiang, A. K. Singh, L. Huang, and M. Yang, "Combating Enhanced Thermal Covert Channel in Multi-/Many-core Systems with Channel-aware Jamming," *IEEE Transactions on Computer-Aided Design of Integrated Circuits and Systems*, vol. 39, no. 11, pp. 3276-3287, 2020.
- X. Deng, F. Da, H. Shao, and Yingtao Jiang, "A Multi-scale Three-dimensional Face Recognition Approach with Sparse Representation-based Classifier and Fusion of Local Covariance Descriptors," *Computer and Electrical Engineering*, vol. 85, 2020.
- L. Zhang, X. Wang, Yingtao Jiang, M. Yang, T. Mak, A. K. Singh, "Effectiveness of HT-assisted Sinkhole and Blackhole Denial of Service Attacks Targeting Mesh Networks-on-chip," *Journal of Systems Architecture*, vol. 89, pp.84-94. 2018.
- X. Ma, Z. Fu, Yingtao Jiang, M. Yang, Haroon Stephen, "Cyberinfrastructure as a Service to Empower Multidisciplinary, Data-Driven Scientific Research," *International Journal of Computer Science and Information Technologies*, vol. 9, no. 3, 2017.
- L. Wang, H. Li, and Yingtao Jiang, "AO-Aloha: A MAC protocol for UAV-WSN systems," *Journal of Distributed Sensor Networks*, vol. 12, no. 8, pp. 1-11, 2016.
- L. Yi, W. Jiao, K. Wu, L. Qian, X. Yu, Q. Xia, K. Mao, S. Yuan, S. Wang, and Yingtao Jiang, "Nanoparticle monolayer-based flexible strain gauge with ultrafast dynamic response for acoustic vibration detection," *Nano Research*, vol. 8, no. 9, pp. 2978-2987, 2015.
- X. Tan, M. Yang, L. Zhang, X. Wang, and Yingtao Jiang, "A Hybrid Optoelectronic Networks-on-Chip Architecture," *IEEE/OSA Journal of Lightwave Technology*, vol. 32, no. 5, pp. 991-998, 2014.

National Security Engineering Research

Dr. Ju-Yeon Jo

Professor, Department of Computer Science

Phone: (702) 895-5873

Email: juyeon.jo@unlv.edu

- Expertise
 - Secure and reliable communication protocol for unmanned aerial vehicles (UAVs)
 - Critical infrastructure / smart grid security
 - Man-in-the-middle (MITM) attack with a tempered SSL certificate detection
 - Thwarting distributed denial of service (DDoS) attacks
 - Digital search warrant
 - Transportation security imaging and secure communication software development

A communication architecture with a two-level wireless mesh network that is secure and scalable.

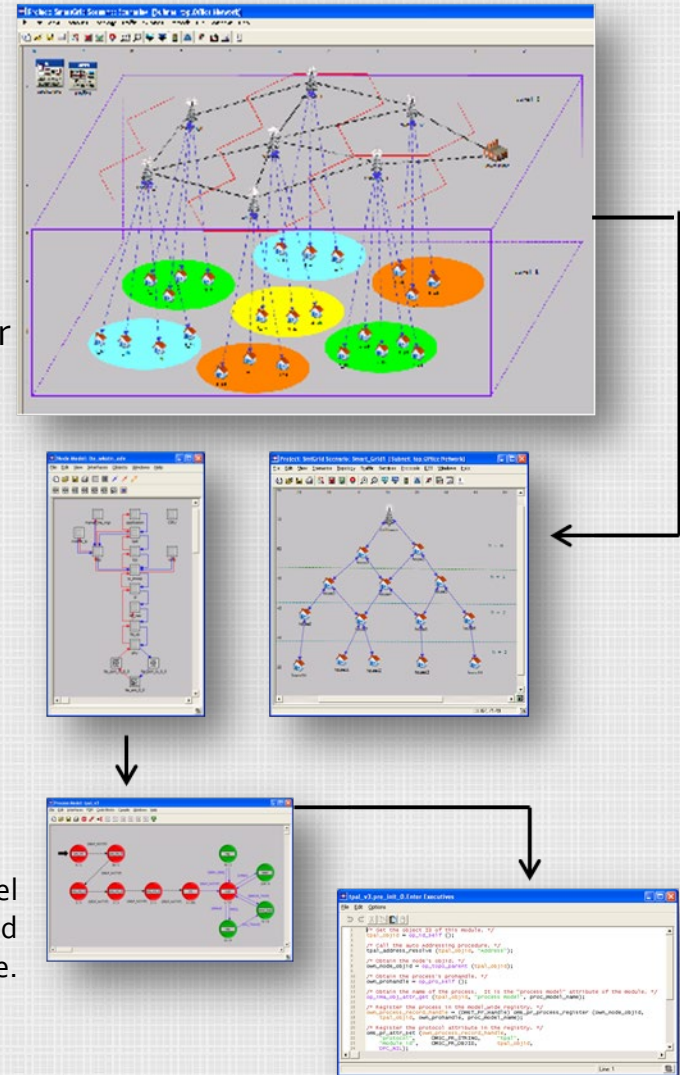

Dr. Ju-Yeon Jo

Professor, Department of Computer Science

Routing Table Population Process

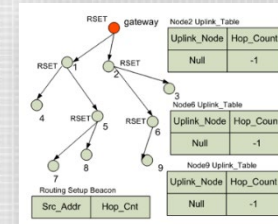

Relevant Publications

- K. Chan, Y. Kim and J.-Y. Jo, "DER Communication Networks and Their Security Issues," 2022 IEEE 12th Annual Computing and Communication Workshop and Conference (CCWC)
- M. D. Salcedo, M. Abid, Y. Kim and J.-Y. Jo, "Evil-Twin Browsers: Using Open-Source Code to Clone Browsers for Malicious Purposes," 2022 IEEE 12th Annual Computing and Communication Workshop and Conference (CCWC)
- CH Park, Y Kim, JY Jo, "A Secure Communication Method for CANBus," 2021 IEEE 11th Annual Computing and Communication Workshop and Conference, 2021.
- Kim Y., Jo J. "Binary Blockchain: Solving the Mining Congestion Problem by Dynamically Adjusting the Mining Capacity". In: Lee R. (eds) *Applied Computing & Information Technology*. ACIT 2017. *Studies in Computational Intelligence*, vol. 727. Springer, Cham, 2018.
- Yoohwan Kim, Ju-Yeon Jo, Sungchul Lee, "ADS-B Vulnerabilities and a Security Solution with a Timestamp," *IEEE Aerospace and Electronic Systems Magazine*, Volume: 32, Issue: 11, Page(s): 52 - 61, 2017.
- Sungchul Lee, Ju-Yeon Jo, and Yoohwan Kim, "Authentication System for Stateless RESTful Web Service", *Journal of Computational Methods in Science and Engineering (JCMSE)*, vol. 17, no. S1, pp. S21-S34, 2017.
- Candace Suh-Lee, Ju-yeon Jo, and Yoohwan Kim, "Text Mining for Security Threat Detection Discovering Hidden Information in Unstructured Log Messages", IEEE Conference on Communications and Network Security (CNS), 2016.
- Yoohwan Kim, Ju-yeon Jo, and Sungchul Lee, "A Secure Location Verification Method for ADS-B", IEEE/AIAA 35th Digital Avionics Systems Conference (DASC), 2016.
- Sungchul Lee, Ju-yeon Jo, and Yoohwan Kim, "Secure and Stateless RESTful Web Service Using ID-Based Encryption", 28th International Conference on Computer Applications in Industry and Engineering, 2015.

Patents

- Ju-yeon Jo and Yoohwan Kim, US Patent App. 14/591,208, 2015, "Obscuring Usernames During a Login Process", filed in 2014.

National Security Engineering Research

Dr. Yoohwan Kim, CISSP, CISA, CEH, CPT

Professor, Department of Computer Science

Phone: (702) 895-5348

Email: yoohwan.kim@unlv.edu

• Expertise

- Secure protocol development for software and network applications
- Critical infrastructure / smart grid / SCADA security and privacy
- Wireless mesh network routing and security
- Distributed denial of service (DDoS) attack prevention
- Secure and reliable communication scheme for unmanned aerial vehicles (UAVs)
- Cybersecurity data analytics
- Security for cryptocurrency and blockchain

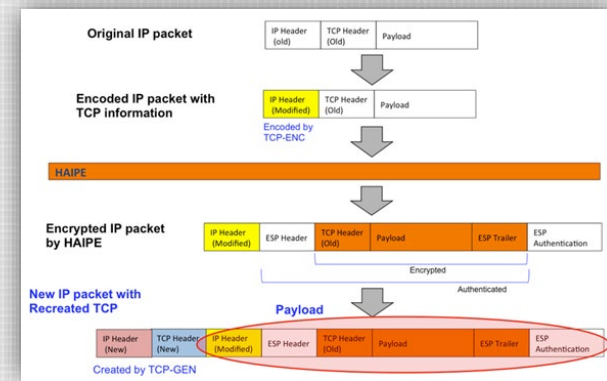
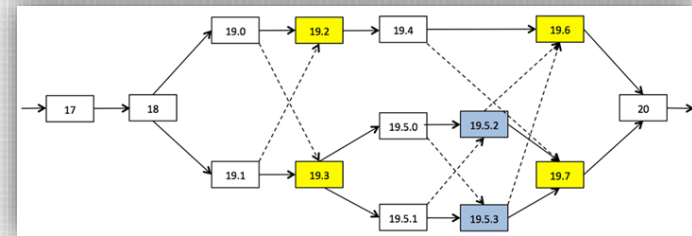
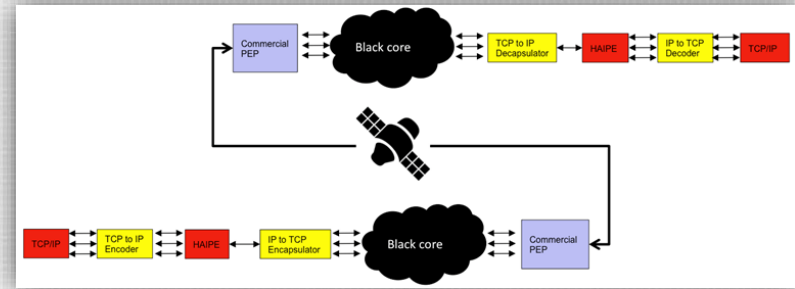

Dr. Yoohwan Kim, CISSP, CISA, CEH, CPT

Professor, Department of Computer Science

Relevant Publications

- K. Chan, Y. Kim and J.-Y. Jo, "DER Communication Networks and Their Security Issues," 2022 IEEE 12th Annual Computing and Communication Workshop and Conference (CCWC)
- M. D. Salcedo, M. Abid, Y. Kim and J.-Y. Jo, "Evil-Twin Browsers: Using Open-Source Code to Clone Browsers for Malicious Purposes," 2022 IEEE 12th Annual Computing and Communication Workshop and Conference (CCWC)
- S. Black and Y. Kim, "An Overview on Detection and Prevention of Application Layer DDoS Attacks," 2022 IEEE 12th Annual Computing and Communication Workshop and Conference (CCWC)
- S. Yiliyaer and Y. Kim, "Secure Access Service Edge: A Zero Trust Based Framework For Accessing Data Securely," 2022 IEEE 12th Annual Computing and Communication Workshop and Conference (CCWC)
- M. E. Zadeh Nojoo Kamar, A. Esmailzadeh, Y. Kim and K. Taghva, "A Survey on Mobile Malware Detection Methods using Machine Learning," 2022 IEEE 12th Annual Computing and Communication Workshop and Conference (CCWC)
- J. Liang and Y. Kim, "Evolution of Firewalls: Toward Securer Network Using Next Generation Firewall," 2022 IEEE 12th Annual Computing and Communication Workshop and Conference (CCWC)
- C. H. Park, Y. Kim and J.-Y. Jo, "A Secure Communication Method for CANBus," 2021 IEEE 11th Annual Computing and Communication Workshop and Conference (CCWC)
- D. Alvarez and Y. Kim, "Survey of the Development of Quantum Cryptography and Its Applications," 2021 IEEE 11th Annual Computing and Communication Workshop and Conference (CCWC)
- D. Anniappa and Y. Kim, "Security and Privacy Issues with Virtual Private Voice Assistants," 2021 IEEE 11th Annual Computing and Communication Workshop and Conference (CCWC)
- X. Liang and Y. Kim, "A Survey on Security Attacks and Solutions in the IoT Network," 2021 IEEE 11th Annual Computing and Communication Workshop and Conference (CCWC)

National Security Engineering Research

Dr. Shahram Latifi, P.E.

Professor, Department of Electrical and Computer Engineering

Director, Center for Information Technology and Algorithms (CITA)

Phone: (702) 895-4016

Email: shahram.latifi@unlv.edu

- Expertise
 - Search and rescue
 - Disaster relief
 - Homeland security
 - Nuclear non-proliferation
 - Biometrics

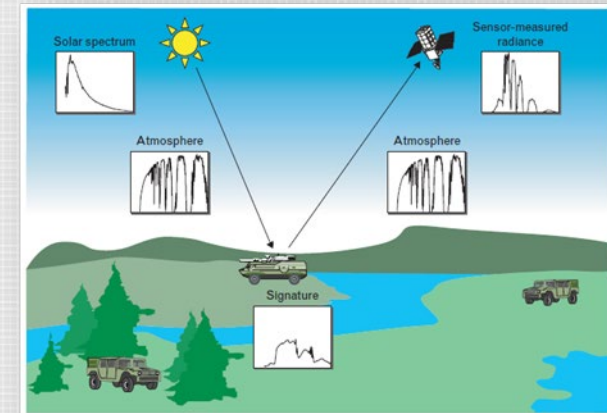
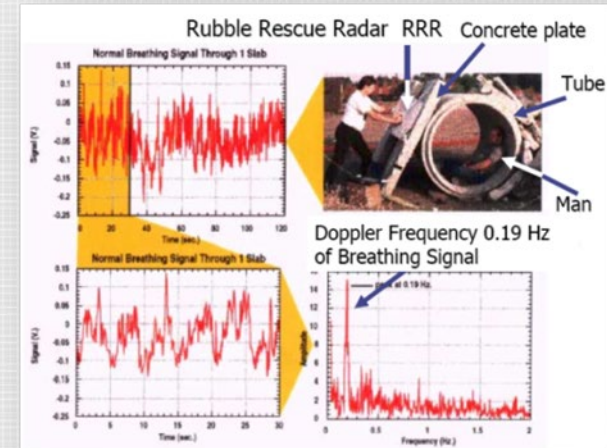

Dr. Shahram Latifi, P.E.

Professor, Department of Electrical and Computer Engineering
Director, Center for Information Technology and Algorithms (CITA)



Relevant Publications

- YB Reddy, S Latifi (2020). "Trust and Access Controls in IoT to Avoid Malicious Activity," *Chapman and Hall/CRC*.
- Tayeb, S., Raste, N., Pirouz, M., Latifi, S. (2018). "A Cognitive Framework to Secure Smart Cities." *MATEC Web of Conferences*, 208 1-6.
- S Tayeb, M Pirouz, G Esguerra, K Ghobadi, J Huang, R Hill, D Lawson, S Latifi, et al. "Securing the positioning signals of autonomous vehicles" (2017) *IEEE International Conference on Big Data*, 4522-4528.
- Shahab Tayeb, Miresmaeil Mirnabibaboli and Shahram Latifi, "Cluster Head Energy Optimization in Wireless Sensor Networks", *Software Networking*, Vol: 2016, Issue: 1, (2018), Article No: 8 Page: 137-162.
- S. Tayeb; M. Pirouz; B. Cozzens; R. Huang; M. Jay; K. Khembunjong; S. Paliskara; F. Zhan; M. Zhang; J. Zhan; Shahram Latifi; "Toward data quality analytics in signature verification using a convolutional neural network", (2017) *IEEE International Conference on Big Data*. Pp. 2644 - 2651.
- S Latifi, "Information Technology-New Generations", *Springer International Publishing* (2016).
- Latifi, S., & Tayeb, S. (2016). "An Evaluative Analysis of DUAL, SPF, and Bellman-Ford". *Software Networking 2018* (1), 1-22.
- Latifi, S., Wilson, S. (2016). "Maximum Distance Band Selection of Hyperspectral Images." *International Journal of Computer Applications*, 133(17), 36-43.
- Chato, L., Latifi, S. (2016). "Improving the Classifier Performance in Detecting People Based on Denoising Wavelet Transform" (pp. 56-61). IEEE: 2016 6th International Conference on IT Convergence and Security (ICITCS).
- Tayeb, S., Mirnabibaboli, M., Latifi, S. (2016). "Load Balancing in WSNs using a Novel Markov Decision Process Based Routing Algorithm" (1st ed., pp. 1-5). IEEE: 2016 6th International Conference on IT Convergence and Security (ICITCS).

National Security Engineering Research

Dr. Brendan O'Toole

Professor, Department of Mechanical Engineering

Phone: (702) 895-3885

Email: brendan.otoole@unlv.edu

- Expertise

- Structural analysis, failure analysis, experimental mechanics
- Structural dynamics, explosives, and impact analysis
- Computational simulation of highly dynamic events
- Material characterization, custom component testing

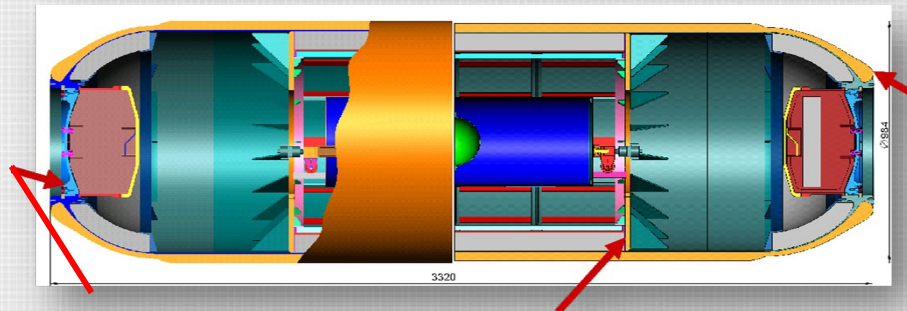

High Strength Steel for Endcaps

Internal Baffling to Distribute Blast Wave

Light Composite for Containment Strength



Dr. Brendan O'Toole

Professor, Department of Mechanical Engineering

Relevant Publications

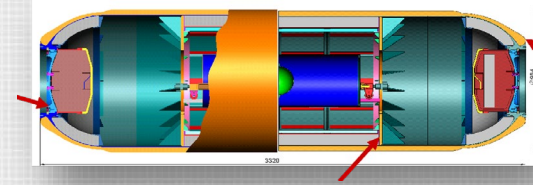

- P. Shojaeishahmirzadi, M. Trabia, B. O'Toole, "Predicting the Projectile Velocity of a Two-Stage Gas Gun Using Machine Learning," ASME PVP, Las Vegas, NV, July 17-22, 2022.
- R. Jazaei, M. Karakouzian, B. O'Toole, J. Moon and S. Gharehdghi, "Energy Dissipation Capacity of Cementitious Nanocomposite Reinforced by Hybrid Carbon Nanotubes", *Construction and Building Materials*, v 323, Article Ref. No. JCBM_126396, 2022.
- P. Shojaei, R. Scazzosi, M. Trabia, B. O'Toole, M. Giglio, X. Zhang, Y. Liao, and A. Manes, "An Approach for Material Model Identification of a Composite Coating Using Micro-Indentation and Multi-Scale Simulations", *Coatings* 2022, 12(1), 92; Jan 14, 2022.
- J. McDonald, M. Pena, S. Satapathy, B. O'Toole, and M. Trabia, "Photon Doppler Velocimetry Measurements of Impact-Induced Surface Waves in Glass and their Role in Fracture Initiation and Damage Evolution", *International Journal of Impact Engineering*, v 161, 104111, 2022. Available online Dec. 9, 2021.
- L. Gallup, M. Trabia, B. O'Toole, Y. Fahmy, "Toward Understanding Large Deflection Bending of 3D Printed NinjaFlex®", *WIT Transactions on Engineering Sciences*, Wessex Institute Press, v 133, pp 55-65, 2021. Originally presented at the 10th International Conference on Computational Methods and Experiments in Material and Contact Characterisation, (online) July 7 – 9, 2021.
- P. Shojaei, R. Scazzosi, M. Trabia, B. O'Toole, M. Giglio, X. Zhang, Y. Liao, A. Manes, "Material Model Characterization of a Ti/SiC Metal Matrix Nanocomposite Coating Subjected to Hypervelocity Impact", *Procedia Structural Integrity* 2020, originally presented at the 1st Virtual European Conference on Fracture, v 28, pp 525-537, 2020.
- P. Shojaeishahmirzadi, M. Trabia, B. O'Toole, "Response of Bolted Flange Joints to Impact Loading", ASME IMECE, Portland OR, 2020.
- P. Shojaei, M. Trabia, B. O'Toole, R. Jennings, X. Zhang, Y. Liao, "Enhancing the Hypervelocity Impact Resistance of Titanium Substrate using Ti/SiC Metal Matrix Nanocomposite Coating", *Composites Part B: Engineering*, Volume 194, August 2020, 108068.
- S. Nelson, B. O'Toole, "Computational Analysis of Blast Loaded Composite Cylinders", *International Journal of Impact Engineering*, Volume 119, pp 26-39 (2018).
- Melissa Matthes, Brendan O'Toole, Mohamed Trabia, et al., "Comparison of Failure Mechanisms Due to Shock Propagation in Forged, Layered, and Additive Manufactured Titanium Alloy," *Dynamic Behavior of Materials*, Volume 1, Springer Verlag (2017), pp. 131-138.

National Security Engineering Research

Dr. Emma Regentova

Professor, Department of Electrical and Computer Engineering

Phone: (702) 895-3187

Email: emma.regentova@unlv.edu

Expertise

- Object reconstruction and material discrimination in sparse-view photon-neutron computed tomography
- Pulsed-ray radioscopy to detect nuclear materials
- Radioscopic cargo screening using mega-voltage energy barriers

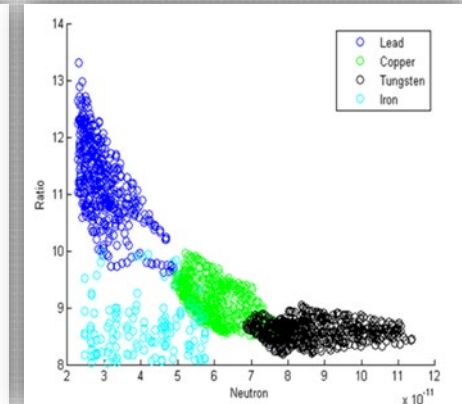
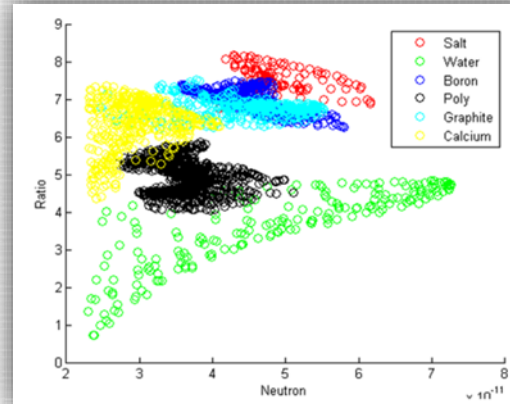

Material discrimination by 2D signatures: Ratio of Photon/Neutron transmission vs. Neutron transmission for various materials.

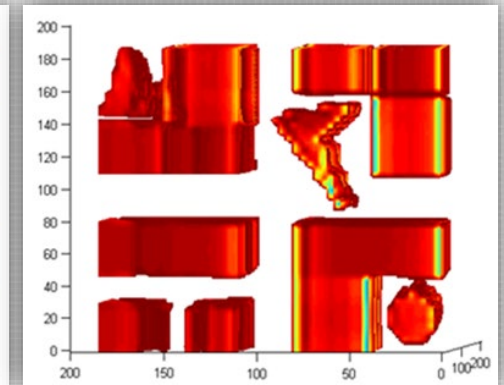
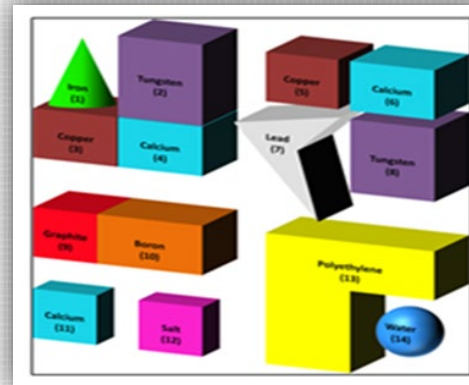

Left: Container under interrogation.

Right: CT reconstruction from the neutron source: 18 views.

Dr. Emma Regentova

Professor, Department of Electrical and Computer Engineering

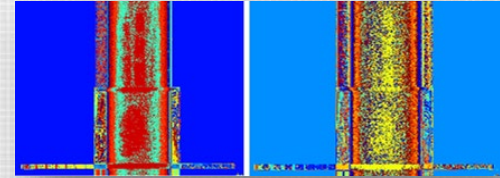

Relevant Publications

- Lan, Y.L., Kamal, A.S., Lopez-Tello, C., (...), Regentova, E.E., Muthukumar, V., "Evaluation of audio denoising algorithms for application of unmanned aerial vehicles in wildlife monitoring", 2018, *Advances in Intelligent Systems and Computing*, 558, pp. 759-766
- Vahidi, V., Yazdanpanah, A.P., Saberinia, E., Regentova, E.E. "Channel estimation, equalisation, and evaluation for high-mobility airborne hyperspectral data transmission", 2016, *IET Communications*, 10(18), pp. 2656-2662
- Ali P., Yazdanpanah, J. Hartman, E. E. Regentova, A. Barzilov, "Object Reconstruction and Material Discrimination in Sparse-View Photon-Neutron Computed Tomography," *IEEE Transactions on Nuclear Science (TNS)*, 2015.
- E. E. Regentova, L. Zhang, V. K.Mandava, A.K. Mandava et al. , "Advances and Challenges of Radioscopic Detection of Nuclear Materials in Cargo Containers with Two Megavoltage Energy Barriers," American Nuclear Society, Radiation Protection and Shielding Division, 2010 Topical Meeting, Las Vegas, 2010.
- Lei Zhang, Ajay K. Mandava, Emma E. Regentova, Zane Wilson, Gongyin Chen, "Radioscopic inspection of cargo containers with megavoltage energy barriers", IEEE International Conference on Systems, Man and Cybernetics, 2009. SMC 2009, 2009, Page(s):3510 – 3515.
- L. Zhang, E. E. Regentova, A. Mandava, V. Mandava, S. Curtis, "Radioscopic Cargo Screening for Detecting Nuclear Materials with Megavoltage Dual Energy Barriers", HPS 2009 Midyear Proceedings, Recent Advances in Planning and Response to Radiation Emergencies, San Antonio, TX, 2009, pp.31-39.

National Security Engineering Research

Dr. Ke-Xun (Kevin) Sun, P.E.

Professor,

Department of Electrical and Computer Engineering

Phone: (702) 774-1486

Email: ke-xun.sun@unlv.edu

- Expertise

- GaN semiconductors and devices
- Radiation-hard electronics, optoelectronics, and imaging systems
- Optics and diffractive optics
- Ultrafast lasers and electronics
- Image analysis
- High Energy Density Physics (HEDP) diagnostics
- CubeSats and formation flight
- Science payload instruments

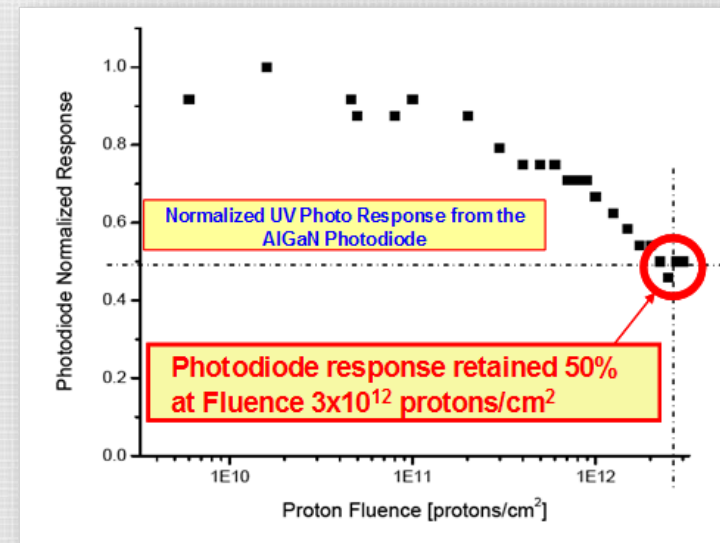



Dr. Ke-Xun (Kevin) Sun, P.E.

Professor,

Department of Electrical and Computer Engineering

Relevant Publications

- Ke-Xun Sun, Hector Valencia, Luis Soriano, Ron Nelson, "Neutron radiation hardness of aluminum gallium nitride UV LEDs at various wavelengths," *Review of Scientific Instruments* 92, 043501 (2021).
- L. Soriano, H. Valencia, K.-X. Sun and R. Nelson, "Fast Neutron Irradiation Effects on Multiple Gallium Nitride (GaN) Device Reliability in Presence of Ambient Variations," 2020 IEEE International Reliability Physics Symposium (IRPS).
- Sun KX, Valles M, Valencia H, Nelson RO, "Gallium nitride (GaN) devices as a platform technology for radiation hard inertial confinement fusion diagnostics." *Rev Sci Instrum.* 2018.
- K. Sun, "High-Sensitivity Fiber Optic Magnetic Field Sensor with Balanced Single Fiber Interferometric Readout," in *Advanced Photonics 2018 (BGPP, IPR, NP, NOMA, Sensors, Networks, SPPCom, SOF), OSA Technical Digest* (online) (Optical Society of America, 2018), paper SeTh1E.1.
- Ke-Xun Sun, "Radiation Hard GaN Devices: LANSCE High Fluence Neutron Tests and NIF High Yield Shot Tests", 2016 National Space & Missile Materials Symposium (NSMMS) & the Commercial and Government Responsive Access to Space Technology Exchange (CRASTE).
- Ke-Xun Sun, "Applications of Robust, Radiation Hard AlGaIn Optoelectronic Devices in Space Exploration and High Energy Density Physics," Invited paper at *CLEO 2011*, 2011, Baltimore, MD.
- Ke-Xun Sun, L. MacNeil, K. Balakrishnan, E. Hultgren, J. Goebel, Y. Bilenko, J. Yang, W. Sun, M. Shatalov, X. Hu, R. Gaska. "Extreme Radiation Hardness and Space Qualification of AlGaIn Optoelectronic Devices". Late Breaking News, International Workshop on Nitride Semiconductors, Tampa, FL, 2010.
- Ke-Xun Sun, N. Leindecker, S. Higuchi, et al, "UV LED Operation Lifetime and Radiation Hardness Qualification for Space Flights," *Journal of Physics CS*, vol. 154, no. 1 (2009).
- Ke-Xun Sun et al, "A LED deep UV source for charge management of gravitational reference sensors," *Classical & Quantum Gravity*. 23 (2006) S141–S150

Patents

- Ke-Xun Sun et. Al., "Grating Angle Magnification Enhanced Angular and Scanners," US Patent 7,599,074 B2.

National Security Engineering Research

Dr. Ying Tian, P.E.

Professor, Department of Civil and Environmental
Engineering and Construction

Phone: (702) 895-4917

Email: ying.tian@unlv.edu

- Expertise

- Progressive collapse resistance of structures
- Large-scale testing of structural components and systems
- Simulation of structures subjected to normal and extreme loading events
- Earthquake engineering

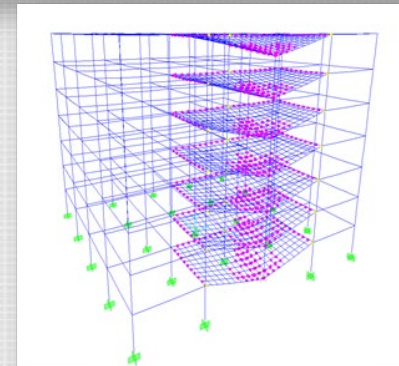
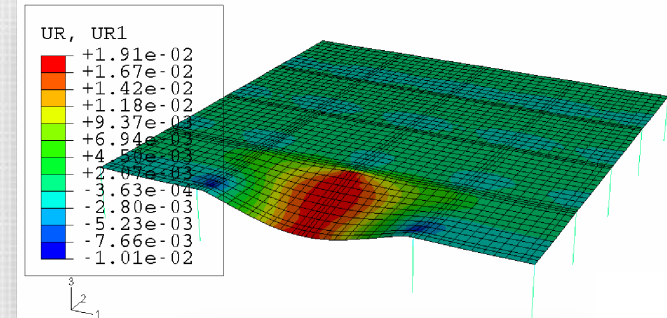

Dr. Ying Tian, P.E.

Professor, Department of Civil and Environmental Engineering
and Construction

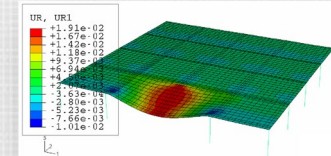

Relevant Publications

- Tian, Y., Liu, X., and George, S. (2020) "Effects of Vertical Ground Motion on Seismic Performance of Reinforced Concrete Flat-Plate Buildings," *Journal of Structural Engineering*, ASCE, 146(12), 04020258.
- Zhang, C., Ma, W., Liu, X., Tian, Y., and Orton, S.L. (2019). "Effects of High Temperature on Residual Punching Strength of Slab-Column Connections after Cooling and Enhanced Post-Punching Load Resistance," *Engineering Structures*, 199, 109580.
- Jawdhari, A., Orton, S., Al-Zuheriy, A., and Tian, Y. (2019) "Response of Flat-Plate Slab-Column Connections under Dynamic Loads during Collapse," *ACI Structural Journal*. 116(5), 55-66.
- Wang, L., Tian, Y., Luo, W., Li, G., Zhang, W., Liu, S., and Zhang, C. (2019) "Experimental Study of Seismic Performance of Axially Restrained Reinforced Concrete Frame Beams," *Journal of Structural Engineering*, ASCE, 145(5), 04019019.
- Zhang, C. and Tian, Y. (2019) "Simplified Performance-Based Optimal Seismic Design of Reinforced Concrete Frame Buildings," *Engineering Structures*, 185, 15-25.
- Li, X., Zhou, X., Tian, Y., and Li, M. (2019) "A Modified Cyclic Constitutive Model for Engineered Cementitious Composites," *Engineering Structures*, 179, 398-411.
- Peng, Z., Orton, S. L., Liu, J., and Tian, Y. (2018) "Experimental Study of Dynamic Progressive Collapse in Flat-Plate Buildings Subjected to an Interior Column Removal", *Journal of Structural Engineering*, ASCE, 144(8), 04018094.
- Xue, H., Gilbert, B. P., Guan, H., Lu, X., Li, Y., and Tian, Y. (2018) "Load Transfer and Collapse Resistance of RC Flat Plates under Interior Column Removal Scenario," *Journal of Structural Engineering*, ASCE, 144(7), 04018087.
- Peng, Z., Orton, S. L., Liu, J., and Tian, Y. (2017) "Experimental Study of Dynamic Progressive Collapse in Flat-Plate Buildings Subjected to an Exterior Column Removal, *Journal of Structural Engineering*. ASCE, 143(9), 04017125.
- Peng, Z., Orton, S. L., Liu, J., and Tian, Y. (2017) "Effects of In-plane Restraint on Progression of Collapse in Flat-Plate Structures," *Journal of Performance of Constructed Facilities*, 3ASCE, 31(3), 04016112.

National Security Engineering Research

Dr. Mohamed Trabia

Professor, ASME Fellow, Department of Mechanical Engineering
Associate Dean for Research, Graduate Studies, and Computing

Phone: (702) 895-0957

Email: mohamed.trabia@unlv.edu

- Expertise
 - Structural analysis, failure analysis, experimental mechanics
 - Structural dynamics, explosives, and impact analysis
 - Computational simulation of highly dynamic events
 - Material characterization, custom component testing

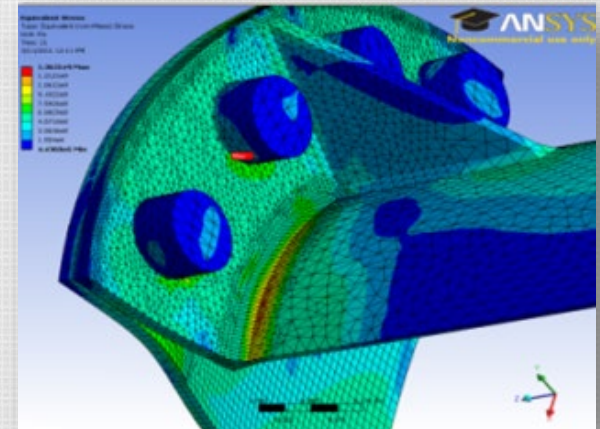

Light composite for containment strength

Dr. Mohamed Trabia

Professor, ASME Fellow, Department of Mechanical Engineering
Associate Dean for Research, Graduate Studies, and Computing

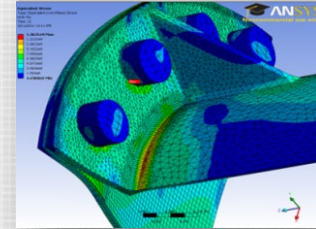

Relevant Publications

- Shojaei, P.; Scazzosi, R.; Trabia, M.; O'Toole, B.; Giglio, M.; Zhang, X.; Liao, Y.; Manes, A. "An Approach for Material Model Identification of a Composite Coating Using Micro-Indentation and Multi-Scale Simulations." *Coatings* 2022, 12, 92.
- Jason McDonald, Michael Pena, Sikhanda Satopathy, Brendan O'Toole, Mohamed Trabia, Richard Jennings, "Photon Doppler velocimetry measurements of impact-induced surface waves in glass and their role in fracture initiation and damage evolution," *International Journal of Impact Engineering*, Volume 161, 2022, 104111, ISSN 0734-743X,
- Pouya Shojaei, Riccardo Scazzosi, Mohamed Trabia, Brendan O'Toole, Marco Giglio, Xing Zhang, Yiliang Liao, Andrea Manes "Material Model Characterization of a Ti/SiC Metal Matrix Nanocomposite Coating Subjected to Hypervelocity Impact," *Structural Integrity Procedia*, 2020.
- Pouya Shojaei, Mohamed Trabia, Brendan O'Toole, Richard Jennings, Xing Zhang, Yiliang Liao "Enhancing Hypervelocity Impact Resistance of Titanium Substrate Using Ti/SiC Metal Matrix Nanocomposite Coating," *Composites Part B*, Volume 194, 2020.
- Xing Zhang, Bo Mao, Rebecca Histed, Mohamed Trabia, Brendan O'Toole, Richard Jennings, Pouya Shojaei, Yiliang Liao "Selective Laser Melting of Ti/SiC Nanocomposite Coating towards Enhanced Surface Performance of Ti64," *Materials Science & Technology* 2019 (MS&T19), Portland, Oregon, 2019.
- M Pena, J McDonald, S Satopathy, B O'Toole, M Trabia. "Surface Waves Generated by Projectile Impact on a Glass Surface," *Nevada Test Site/National Security Technologies, LLC* (United States) (2017).
- J Limido, M Trabia, S Roy, B O'Toole, R Jennings, WL Mindle, M Pena, et al. "Modeling of Hypervelocity Impact Experiments Using Gamma-SPH Technique." ASME 2017 Pressure Vessels and Piping Conference (2017).
- Melissa Matthes, Brendan O'Toole, Mohamed Trabia, et al., "Comparison of Failure Mechanisms Due to Shock Propagation in Forged, Layered, and Additive Manufactured Titanium Alloy," *Dynamic Behavior of Materials, Volume 1*, Springer Verlag (2017), pp. 131-138.
- S. Roy, M. Trabia, B. O'Toole, R. Hixson, S. Becker, M. Pena, R. Jennings, D. Somasundaram, M. Matthes, E. Daykin, and E. Machorro, "Study of Hypervelocity Projectile Impact on Thick Metal Plates," *Shock and Vibration, Volume 2016* (2016), Article ID 4313480.
- D. Somasundaram, M. Trabia, and B. O'Toole, "Parametric Sensitivity Comparison of Simulation Models for Flyer Plate Impact Experiments," *International Journal of Computational Methods and Experimental Measurements*, Vol. 3, Issue 4, pp. 305 - 315 (2015).

National Security Engineering Research

Dr. Zuobin Xiong

Assistant Professor, Department of Computer Science

Email: zuobin.xiong@unlv.edu

- Expertise

- Differential privacy
- Private data publishing
- Distributed learning
- Cybersecurity
- Adversarial attacks
- Security and privacy in AI
- Trustworthy ML/AI

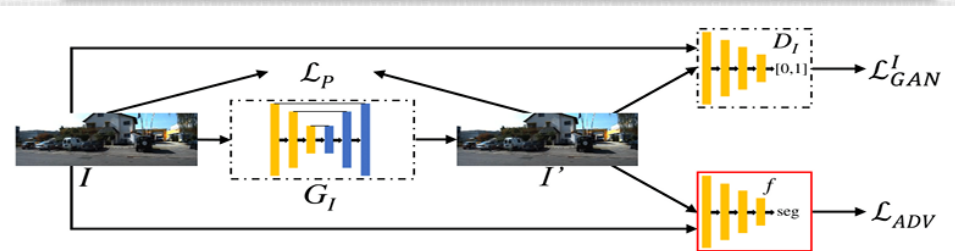
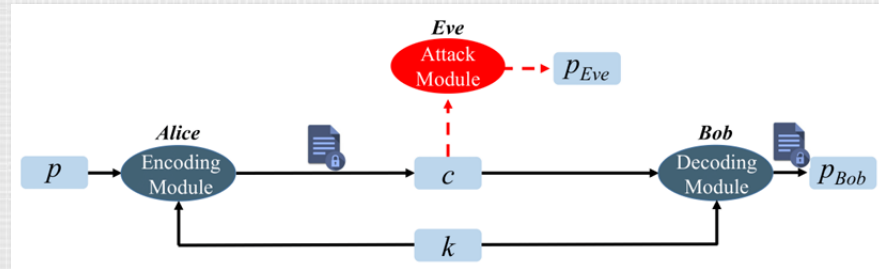

(a) Image pipeline of parallel attack model

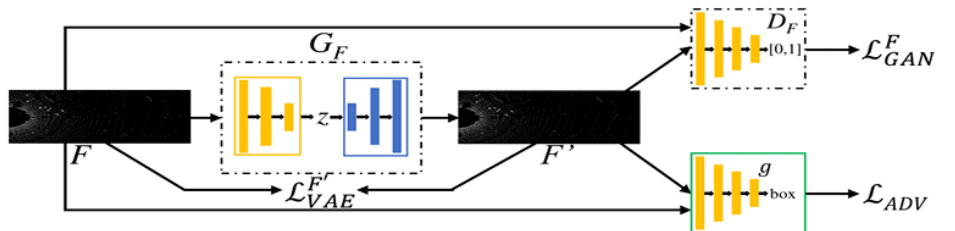

(b) LiDAR pipeline of parallel attack model

Dr. Zuobin Xiong

Assistant Professor, Department of Computer Science

Relevant Publications

- Lu, G., Xiong, Z., Li, R., Mohammad, N., Li, Y. and Li, W., 2023. "DEFEAT: A decentralized Federated Learning against gradient attacks." *High-Confidence Computing*, p.100128.
- Lu, G., Xiong, Z., Li, R. and Li, W., 2022, November. "Decentralized Federated Learning: A Defense Against Gradient Inversion Attack." In International Wireless Internet Conference (pp. 44-56). Cham: Springer Nature Switzerland.
- Xiong, Z., Cai, Z., Hu, C., Takabi, D. and Li, W., 2022. "Towards neural network-based communication system: Attack and defense." *IEEE Transactions on Dependable and Secure Computing*.
- Lu, G., Xiong, Z., Meng, J. and Li, W., 2022, December. "Pairwise Gaussian Graph Convolutional Networks: Defense Against Graph Adversarial Attack." In GLOBECOM 2022-2022 IEEE Global Communications Conference (pp. 4371-4376). IEEE.
- Xie, B., Xu, H., Xiong, Z., Li, Y. and Cai, Z., 2022, August. "A Self-Supervised Purification Mechanism for Adversarial Samples." In 2022 IEEE International Conferences on Smart Data (SmartData) (pp. 501-509). IEEE.
- Wang, J., Xiong, Z., Han, Q., Han, X. and Yang, D., 2021. "Top-k socially constrained spatial keyword search in large IoT networks." *IEEE Internet of Things Journal*, 9(12), pp.9280-9289.
- Xiong, Z., Cai, Z., Takabi, D. and Li, W., 2021. "Privacy threat and defense for federated learning with non-iid data in AIoT." *IEEE Transactions on Industrial Informatics*, 18(2), pp.1310-1321.
- Cai, Z., Xiong, Z., Xu, H., Wang, P., Li, W. and Pan, Y., 2021. "Generative adversarial networks: A survey toward private and secure applications." *ACM Computing Surveys (CSUR)*, 54(6), pp.1-38.
- Xiong, Z., Xu, H., Li, W. and Cai, Z., 2021. "Multi-source adversarial sample attack on autonomous vehicles." *IEEE Transactions on Vehicular Technology*, 70(3), pp.2822-2835.
- Xiong, Z., Cai, Z., Han, Q., Alrawais, A. and Li, W., 2020. "ADGAN: Protect your location privacy in camera data of auto-driving vehicles." *IEEE Transactions on Industrial Informatics*, 17(9), pp.6200-6210.

National Security Engineering Research

Dr. Mei Yang

Professor, Department of Electrical and Computer Engineering

Phone: (702) 895-2364

Email: mei.yang@unlv.edu

- Expertise
 - Computer architecture, multi/many-core systems
 - Interconnection networks, photonic interconnects
 - Networks-on-chip
 - Wireless sensor networks
 - Biometrics, image analysis
 - Machine learning

Collaboration with Dr. Jiang
(engineering)

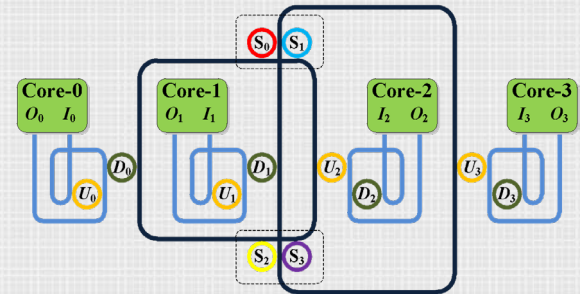

Collaboration with
Drs. Regentova
(engineering) &
Schneider
(nursing)

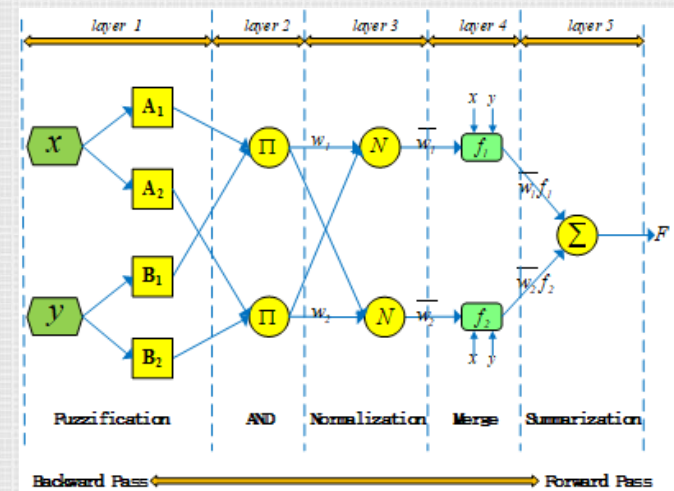
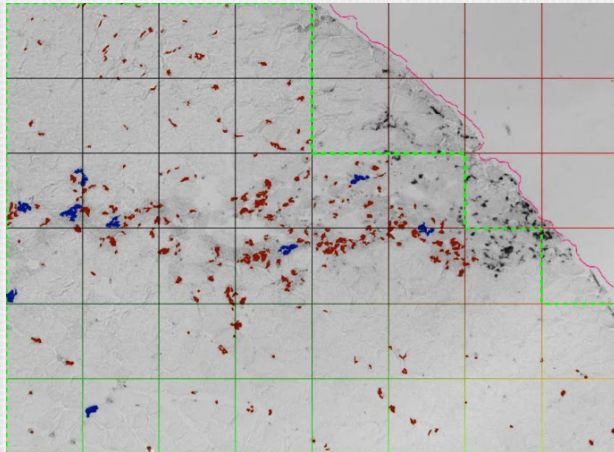

Collaboration with Drs. Batista & Jiang
(engineering)

Dr. Mei Yang

Professor, Department of Electrical and Computer Engineering

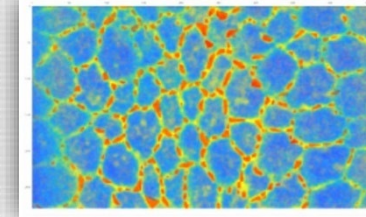

Relevant Publications

- Huang H.; Wang X.; Jiang Y.; Singh A.K.; Yang M.; "IEEE Transactions on Computer-Aided Design of Integrated Circuits and Systems", *Detection of and Countermeasure Against Thermal Covert Channel in Many-Core Systems*, Volume 41, Issue 2, Pages 252 - 2651 (2022).
- Zhao, Y., Wang, X., Jiang, Y., (...), Huang, L., Yang, M.; "An enhanced planned obsolescence attack by aging networks-on-chip" (2021) *Journal of Systems Architecture*, 117,10209
- S. Wen, X. Wang, A. Singh, Y. Jiang and Mei Yang, "Performance Optimization of Many-core Systems by Exploiting Task Migration and Dark Core Allocation," *IEEE Transactions on Computers*, Available online, 2020.
- Y. Jiao, M. Weng, and Mei Yang, "Multi-object portion tracking in 4D fluorescence microscopy imagery with deep feature maps," Proc. of IEEE/CVF Conf. and Computer Vision and Pattern Recognition (CVPR), 2019.
- Y. Jiao, B.S.P. Schneider, E. Regentova, and M. Yang, "DeepQuantify: deep learning and quantification system of white blood cells in light microscopy images of injured skeletal muscles," *Journal of Medical Imaging*, vol. 6, no. 2, 2019.
- L Zhang, X Wang, Y Jiang, Mei Yang, T Mak, AK Singh. "Effectiveness of HT-assisted sinkhole and blackhole denial of service attacks targeting mesh networks-on-chip." *Journal of Systems Architecture* 89, 84-94 (2018).
- Y. Jiang, Mei Yang, "Circuit design of Clos-based on-chip interconnection networks," *Microprocessors and Microsystems*, vol. 46-B, pp. 184-192 (2016).
- X. Wang, B. Zhao, T. Mak, Mei Yang, Y. Jiang, and M. Daneshtalab, "An efficient runtime power allocation scheme for many-core system inspired from auction theory," vol. 50, *Integration, the VLSI Journal*, pp. 147- 157 (2015).
- X. Tan, Mei Yang, L. Zhang, X. Wang, and Y. Jiang, "A hybrid optoelectronic networks-on-chip architecture," *IEEE Journal of Lightwave Technology*, vol. 32, no. 5, pp. 991-998 (2014).
- L. Zhang, Y. Man, X. Tan, Mei Yang, T. Hu, J. Yang, and Y. Jiang, "On reducing insertion loss in wavelength routed optical network-on-chip architecture," *IEEE/OSA Journal of Optical Communications and Networking*, vol. 6, no. 10, pp. 879-889 (2014).