

Numerical Methods Research

Zhonghai Ding

- Professor of Mathematics
Department of Mathematical Sciences
- Ph.D. in Mathematics
Texas A&M University, College Station, Texas
- CDC 1004, Zhonghai.Ding@unlv.edu
- <https://faculty.unlv.edu/zding/>



Areas of Expertise

- Control Theory
- Partial Differential Equation
- Mathematical Modeling
- Numerical Computation

Research Summary:

Dr. Ding's research interests are in mathematical modeling and analysis, control, and computation of problems arising from real applications such as nematic liquid crystals, suspension bridge systems, shape memory alloys, oxidation of metal matrix composites, control of dynamical systems, etc.. These systems are governed by linear or nonlinear partial differential equations. Dr. Ding's research focus on analyzing system behaviors, developing numerical methods for solutions, and investigating related control issues.

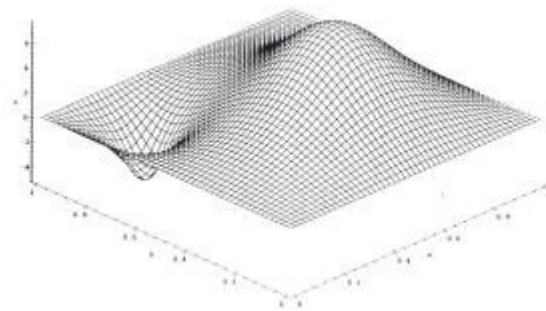
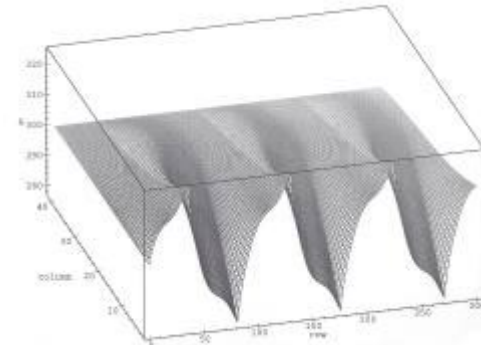

Scientific Computing and Mathematical Modeling

- **Dr. Jichun Li**
- Full Professor
- Department Mathematical Sciences
- Email: jichun.li@unlv.edu
- Website: <http://faculty.unlv.edu/jichun/>

Expertise

- Computational Electromagnetics: wave propagation in metamaterials, graphene, and other complex media.
- Develop, analyze, and implement various numerical methods for solving various Differential Equations (DEs) in sciences and engineering.
- Machine Learning; Math finance; Numerical Analysis.

Published over 2 books, and over 140 SCI papers

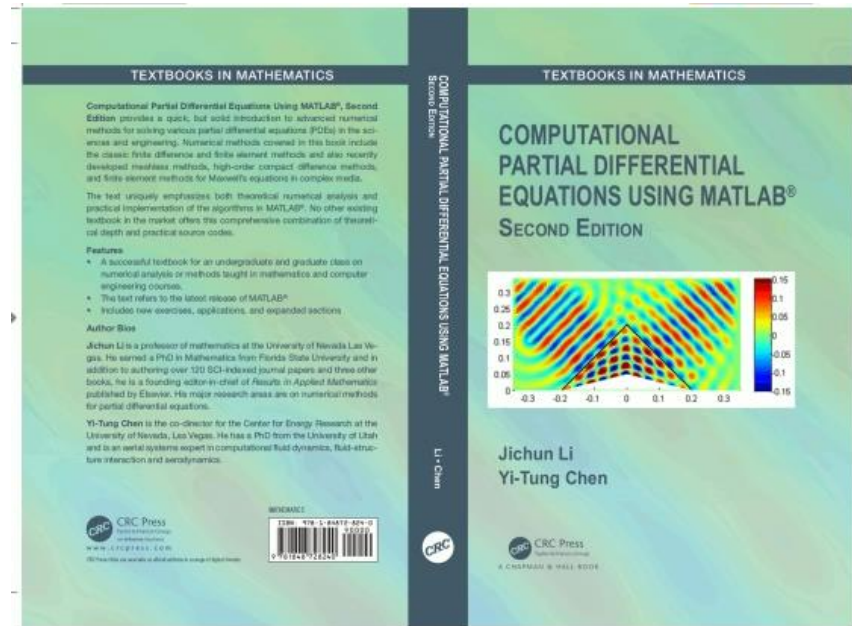
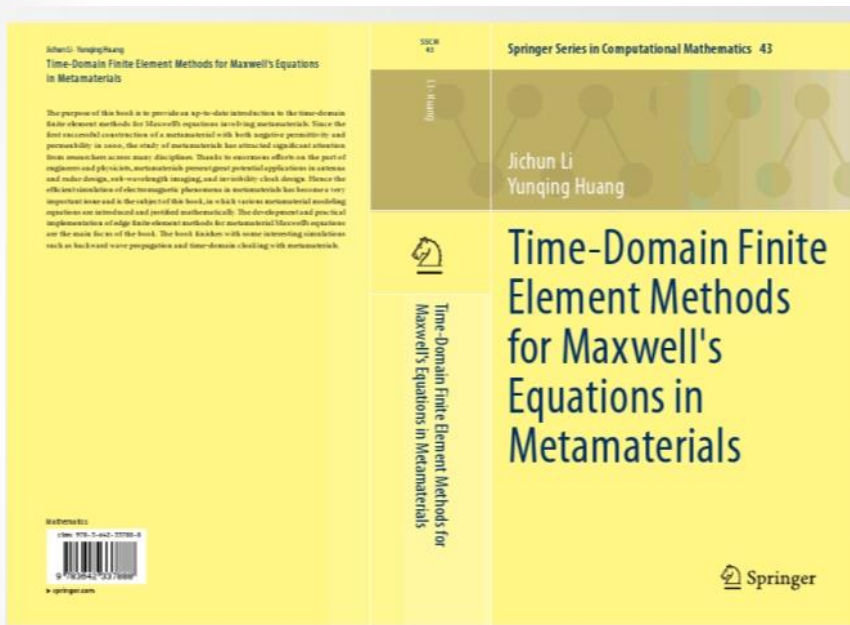

In 2023, ranked #1097 (out of total 1138) in United States and #2638 in the world in The 2nd edition of Research.com ranking of the best scholars in the arena of Mathematics: <https://research.com/scientists-rankings/mathematics/>

Computational Fluid Dynamics

- **Dr. Monika Neda**
- Professor, Department of Mathematical Sciences
- monika.neda@unlv.edu
- <https://faculty.unlv.edu/neda/>



Expertise

- Computational Fluid Dynamics
- Turbulence
- Numerical Methods for Partial Differential Equations
- Applied Sensitivity Analysis
- STEM education

Simulation of fluid flow: Calculations of drag and lift

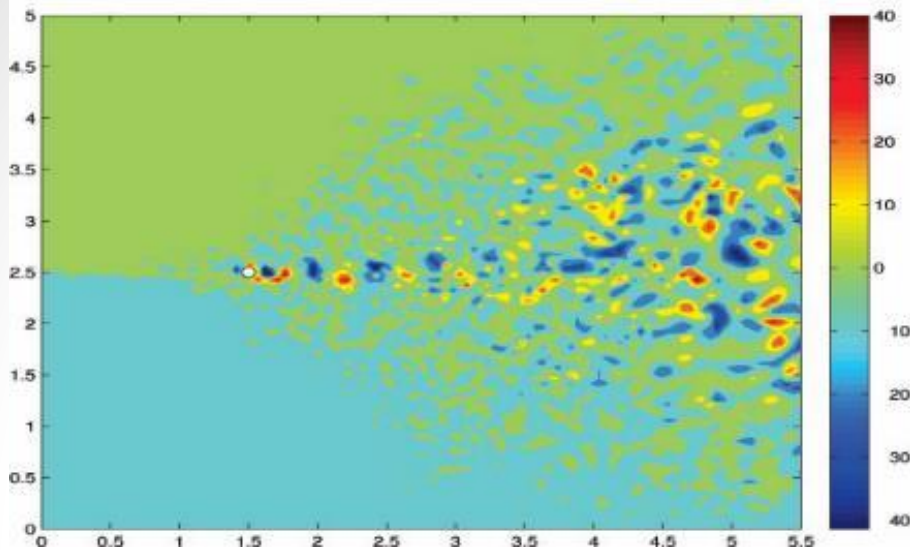

The figure (left side) presents the creation of the vortex street behind an immersed body in a fluid. It can be used to compute drag and lift in aerodynamics, such as drag and lift of aircrafts.

Simulation of fluid flow:
Creation of eddies/vortices
behind the step

The figure (right side)
depicts the creation of the
rotational structures
behind the step as a result
of the interaction of the
fluid with boundaries.

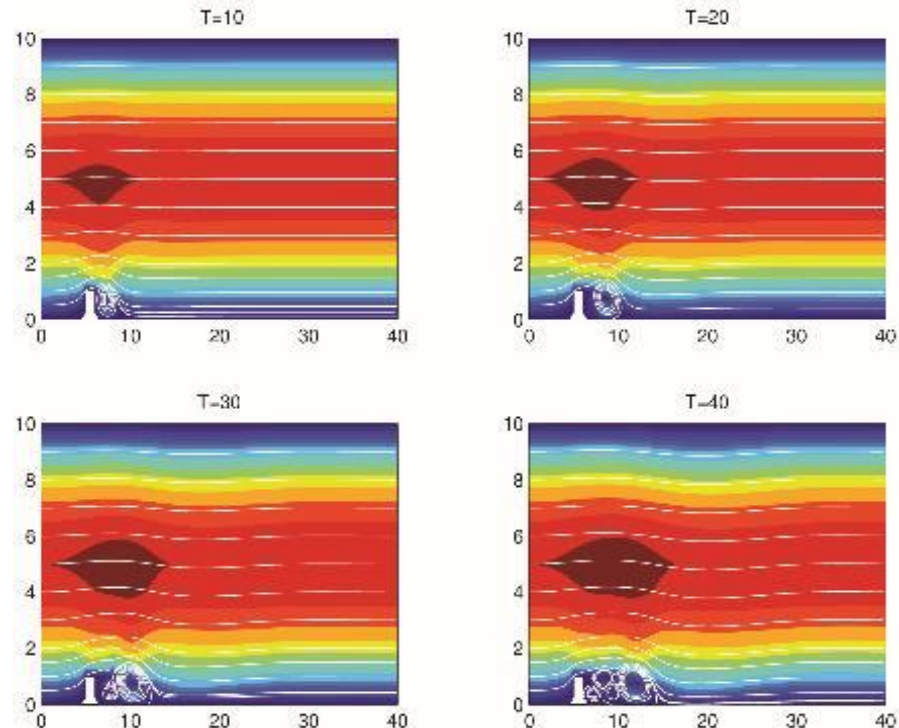

Advanced Numerical Methods for Moving Domain/Interface Multi-Physics Problems

Dr. Pengtao Sun

Professor

Department of Mathematical Sciences

Email: pengtao.sun@unlv.edu ; URL: <https://faculty.unlv.edu/sun/>

Expertise

- Numerical Solutions of Partial Differential Equations (PDE)
- Numerical Analysis (Well-posedness, Stability, Convergence)
- Finite Element/Volume/Difference Methods
- Scientific and Engineering Computing
- Fluid-Structure Interaction (FSI) Modeling and Simulation
- Fuel Cell Dynamics, Fluid Dynamics, Electrohydrodynamics

Fluid-Hydro Turbine Interaction Problems

- Hydroelectric power generating system produces renewable energy and remains crucial for society and industry. The most significant part of this system is the hydro turbine interacting with the water flow, which involves elastic solid materials and viscous fluids and belongs to the category of fluid-structure interaction (FSI). The developments of mathematical models and numerical methodologies are critical in practice for efficient simulations of the hydro turbine, which in turn guides the design and evaluation.
- We approach the challenges in different aspects. First, based on the observation that the hydro turbine, although exhibiting large rotations, has relatively small deformation, we develop linearized elasticity equations that alleviate the burden on nonlinear solver and improves the well-posedness of spatial discretization. Second, we propose a new approach to solve the arbitrary Lagrangian-Eulerian mesh motion for rotating structure. Moreover, we analyzed the well-posedness and convergence of the finite element discretization and demonstrated the discretization is solver friendly.

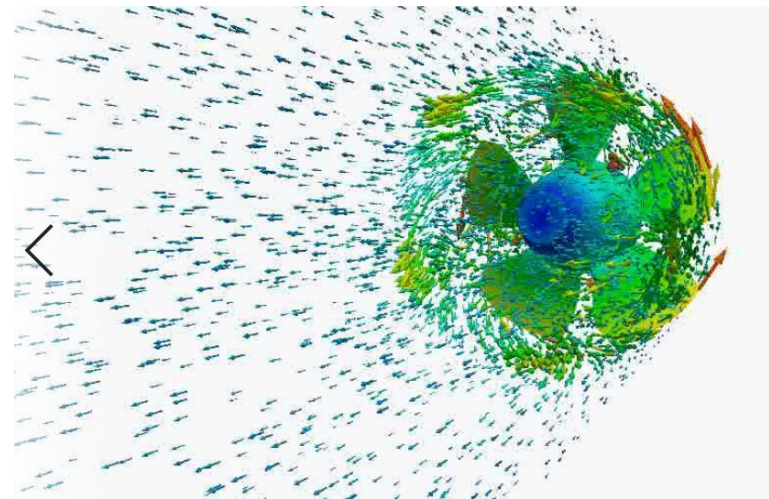
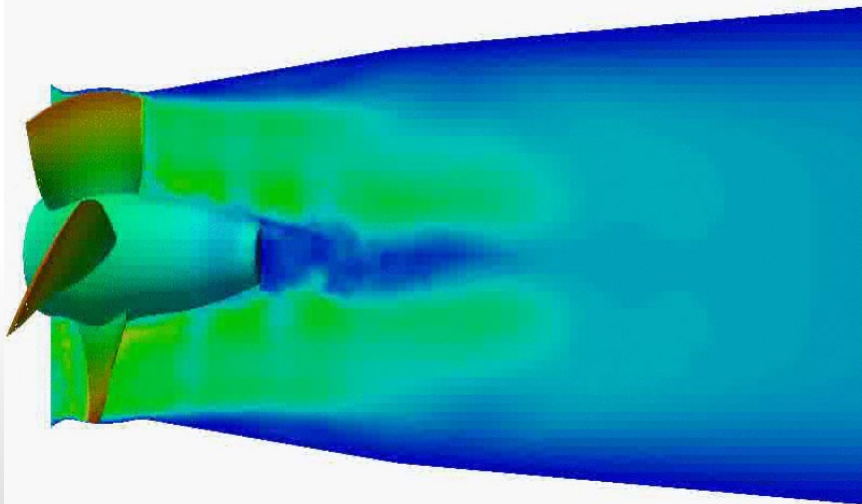

Hemodynamic Fluid-Structure Interaction (FSI) Problems

- FSI simulation has become the most promising solution method to solve the hemodynamic problem existing in the clinical cardiovascular system. However, the complexity of cardiovascular environment, the artificial heart pump model, the vascular rupture, the aneurysm progression and the aortic dissection cause the deficiency of the existing FSI simulation package towards the clinical demands.
- We devoted our research to the new modeling and numerical techniques for the bloodstream-vascular-stent graft/artificial heart pump interaction problems, aiming at overcoming numerical difficulties and challenges, and developed advanced numerical methodologies to improve the efficiency and accuracy of corresponding FSI simulations. and to deliver more instructive numerical results to medical professionals for helping out patients on an efficient and accurate diagnosis and treatment.

